

## Product Specification

V 1.0



Series-1 0812  
AfterGlow Neon-Flex  
(Glow in the dark effect)

**For 6 Hours**  
 Light Storing  
 Visible Light Can Be Maintained



### Guide Icon



### Product Ordering Code

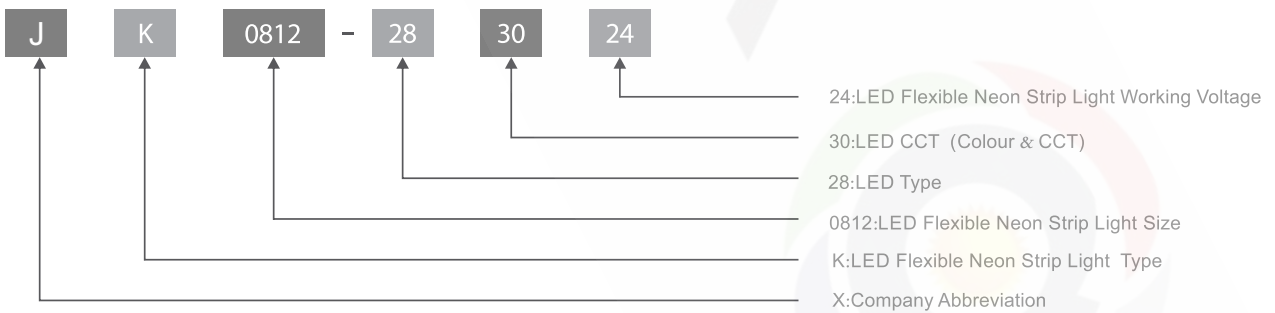

## Physical Specifications

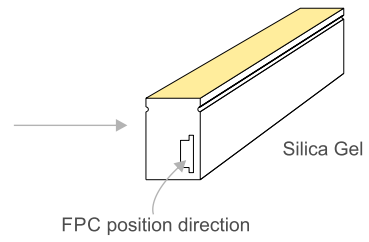
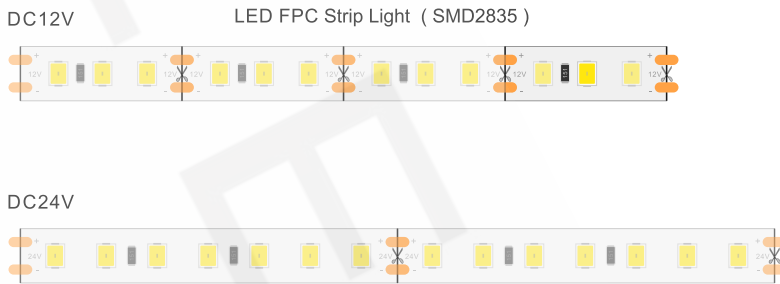

## Bending Direction

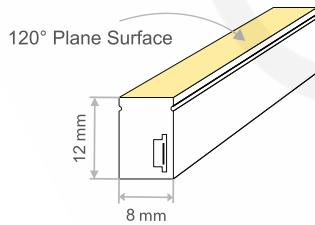

## Product breakdown diagram

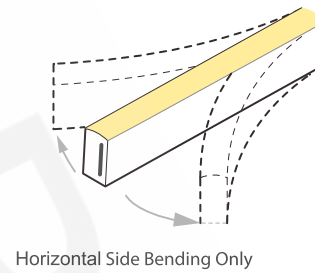
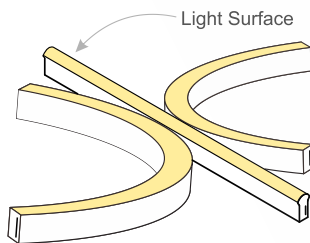
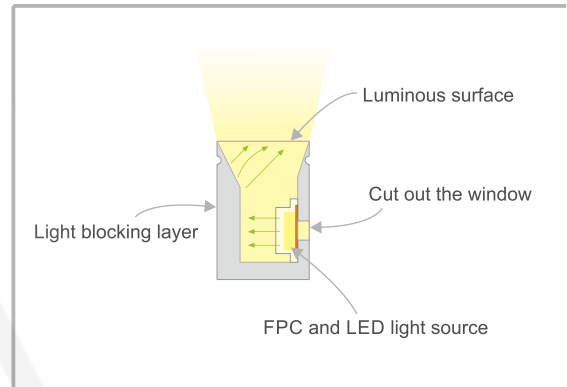

## Minimum Bending Diameter

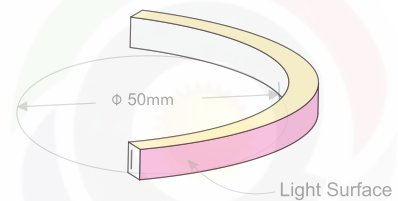
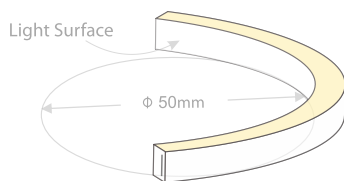

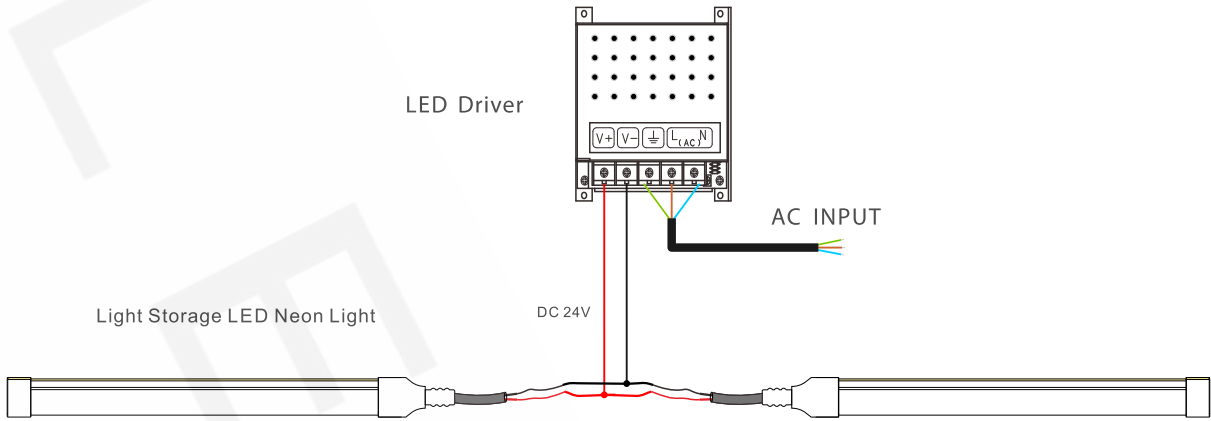

## Loading Chart

Rated Power	Power Supply
	66W
11W/m	5m

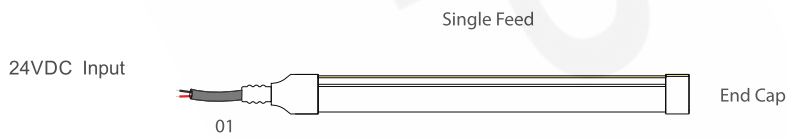



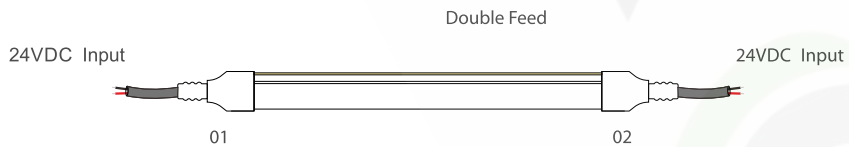

Rated Power	Power Supply
	140W
11W/m	10m



**Note:** These are the max recommended run lengths based on power supply.

**For example:** It is recommended to use one 140W power supply for a double-fed run of 10m at 11W/m. Power supply is guaranteed to remain 20% surplus.

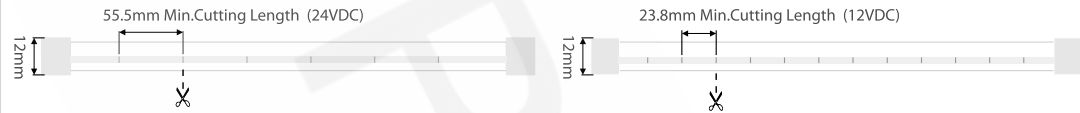
## Product technical parameters

Working Voltage	24V DC	12V DC
Light-Storing	For 6 hours	
Light Profile	 Plane Surface	
Size(W*H)	 8X12mm	
Lighting CCT	<span style="background-color: yellow; border: 1px solid black; padding: 2px;">W</span> WW <span style="background-color: #fff9c4; border: 1px solid black; padding: 2px; margin-left: 10px;">N</span> NW <span style="background-color: #bbdefb; border: 1px solid black; padding: 2px; margin-left: 10px;">C</span> CW	
Control colors	Single Color	
LED Type	SMD 2835	
Rated Power/m	11W	
Luminous flux(lm/m)	>450-500lm	
CRI	>80 ; >90	
FPC Light Direction	Vertical	
Continuous Length (Single End Feeding)	5m	
Continuous Length (Double Ends Feeding)	10m	
IP Rating	IP 65	
working temperature	-20°C~60°C	
LED Qty/m	126LEDs	
Min.Cutting Unit	7LEDs	3LEDs
LED Point Spacing		
Min.Cutting Length		

## LED Strip Light Loading Chart Conventional wiring

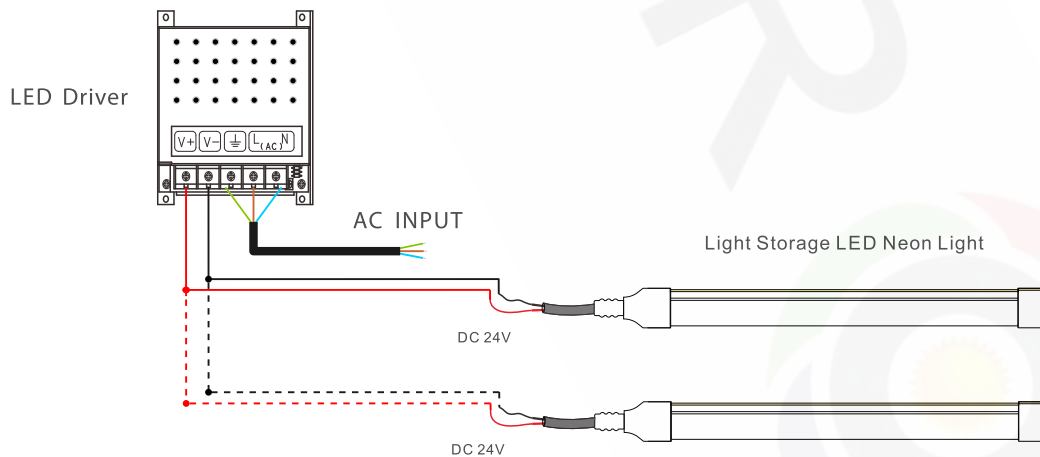

Application scenario

---

on



VS

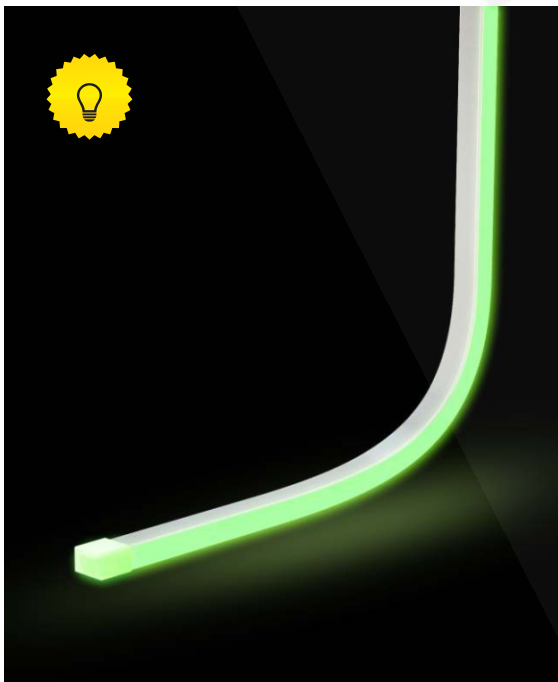
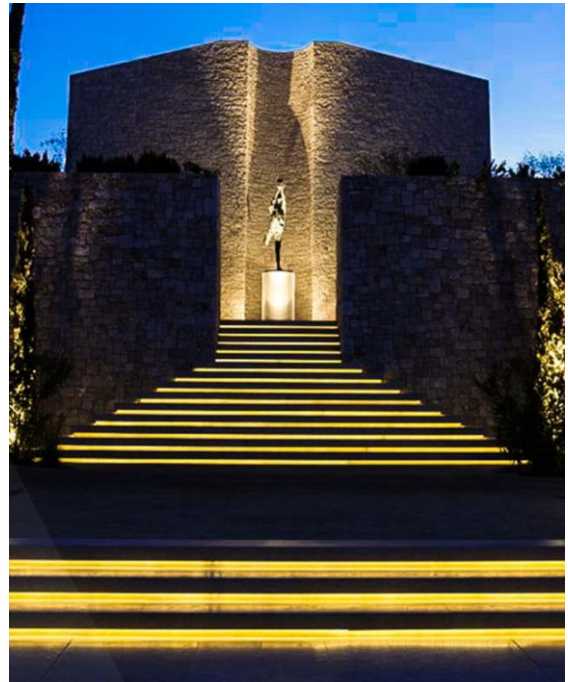

VS

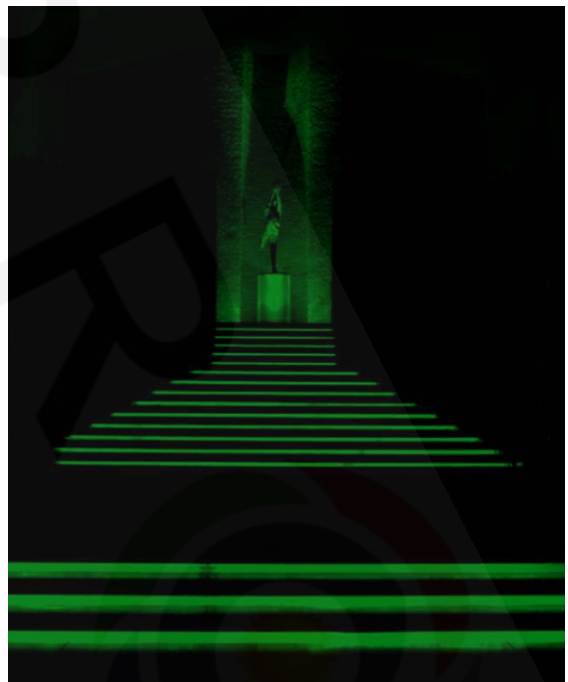

## Optional Accessory information



Fixed clip  
0.3mm stainless ,with screws  
10\*6.4\*7.4mm  
4PCS/1m

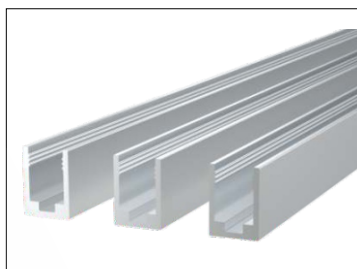

Aluminium profile  
Aluminium profile,flat mounting  
1000\*6.5\*9.1mm  
1PCS/1m



End cap  
Translucent, silica gel  
10\*7\*13.5mm  
2PCS

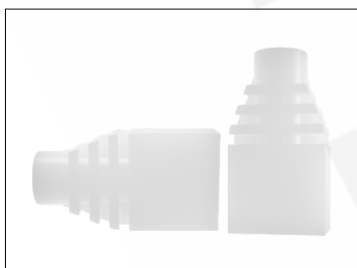

Top cap  
Translucent, silica gel  
32\*14\*8mm  
One end/1PCS  
Dual ends/2PCS



AWM 2464, 20AWG,0.5m<sup>2</sup>  
L=200mm  
One end/1PCS  
Dual ends/2PCS

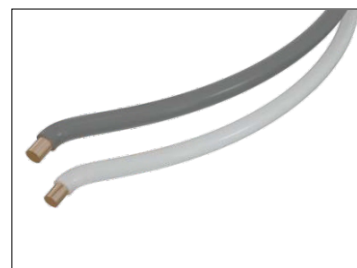

AWM, 22AWG,0.5m<sup>2</sup>  
L=200mm  
One end/1PCS  
Dual ends/2PCS

## Packaging



Packing Reel



Packing carton



Packing Box

Fixture Length	Product quantity/carton	Carton N.W.	Carton G.W.	Carton size
5m	100m/1carton	10.5kg	11.7kg	57x29x22.5cm